

ALUMINIUM CLAD LIFT & SLIDE DOOR

TITLE

ELEVATION DRAWING

DRAWING No.

LS-A-78/01

DATE

2020/11/17

SCALE

CONSTRUCTION DETAILS

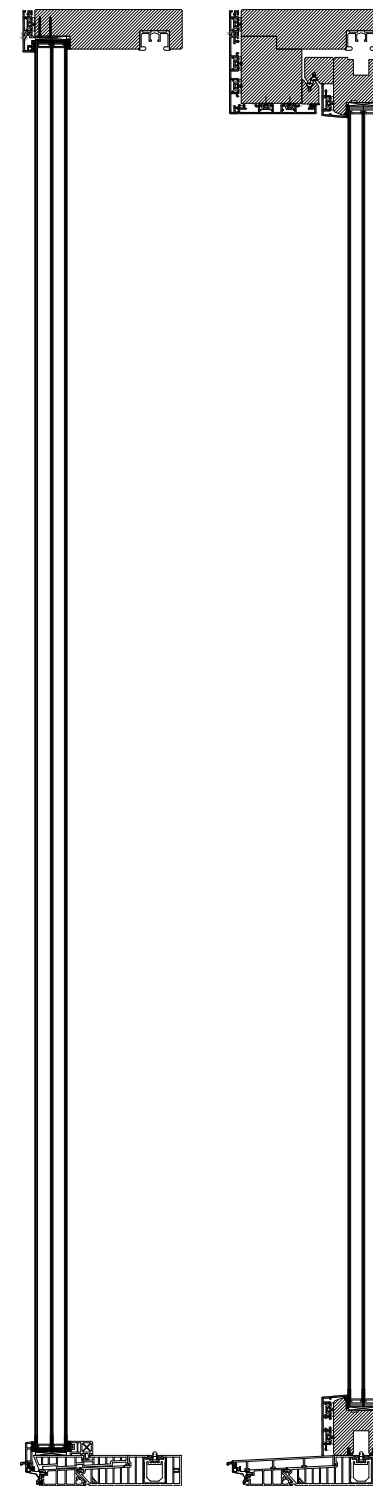
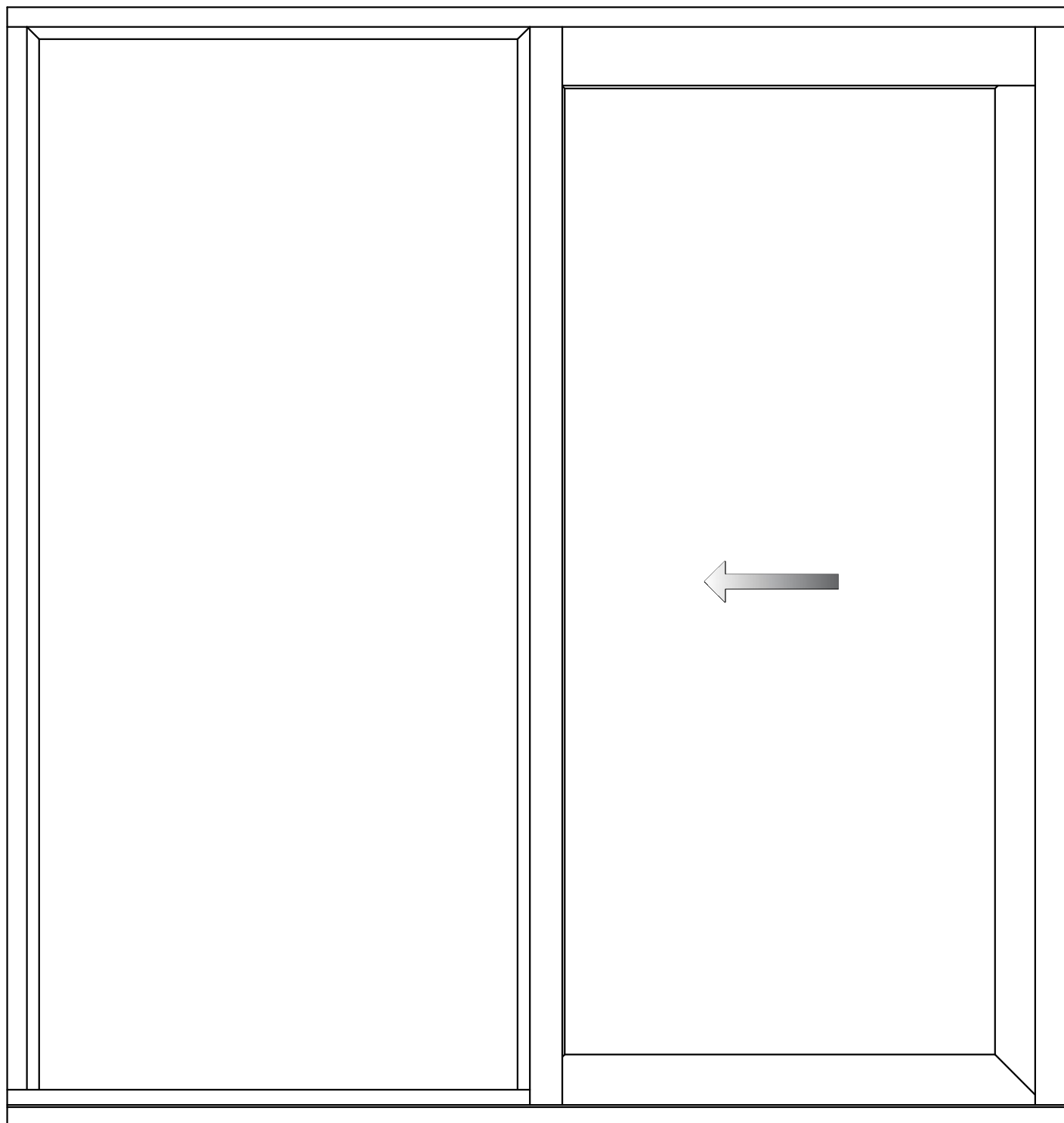

Material	Manufactured in selected engineered laminated pine or hardwood, sourced from sustainable and managed forestry (FSC or PFEC certified)
Mechanism	Sash is lifted with the comfort gear and slides the bottom rail with the help of wheels, which can carry up to 400kg sash weight
Security (optional)	Fully tested to Secure by design standards PAS 24:2016
Weatherseal	The window is fully weather sealed to BS EN 6375-1 2009
Glass	The window is factory glazed and can take triple sealed units up to 48mm thickness
Thermal Performance	Thermal performance is calculated by the standards of EN ISO 10077-1:2006 and this window achieves a U-value of 1.4 W/m ² K or better
Fittings	Lift and Slide door handle coordinated with the sash weight and hardware, recessed pull handle externally with options in colour and finish. Locking cylinder is an option
Factory Finishing	To ensure the smooth operation and optimum performance of the window, we apply 3 coats of sprayed applied microporous water based paint system

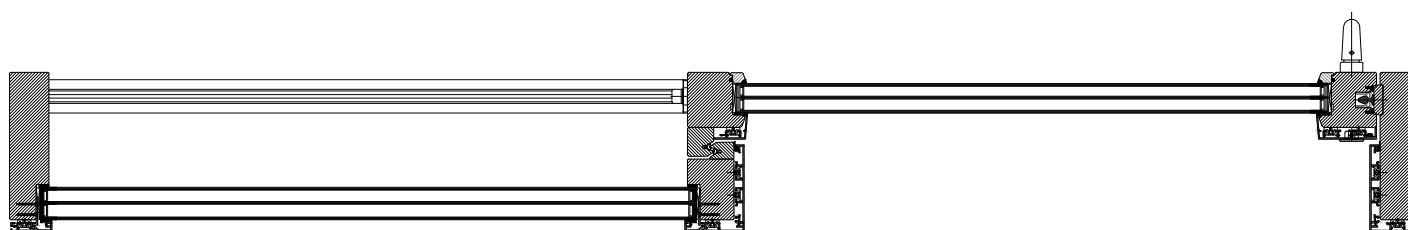

TRC CONTRACTS Ltd
Knoll House, Union Wharf,
Market Harborough,
Leicestershire LE16 7UW
Tel: +44 (0)1858 469 225
Fax: +44 (0)1858 469 249
www.trcwindows.co.uk

TRC ARE AN ISO 9001 REGISTERED COMPANY



ALUMINIUM CLAD LIFT & SLIDE DOOR

TITLE

VERTICAL SECTION

DRAWING No.

LS-A-78/02

DATE

2020/11/17

SCALE

1:2 @ A3

CONSTRUCTION DETAILS

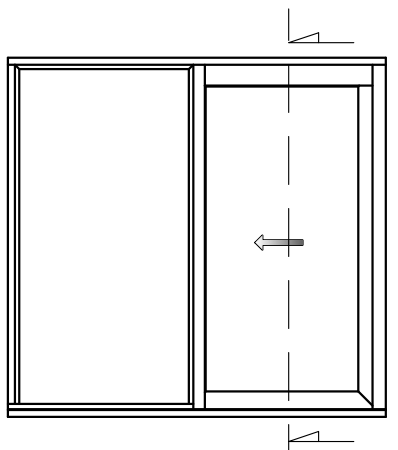
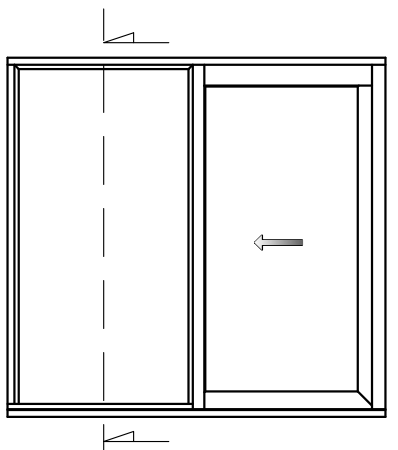
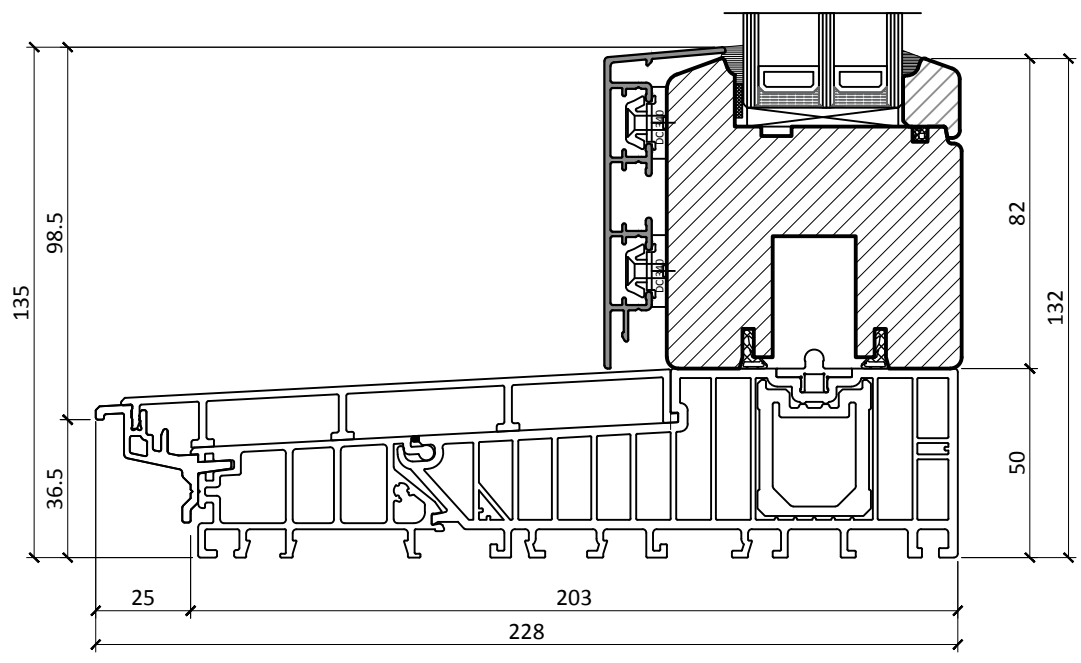
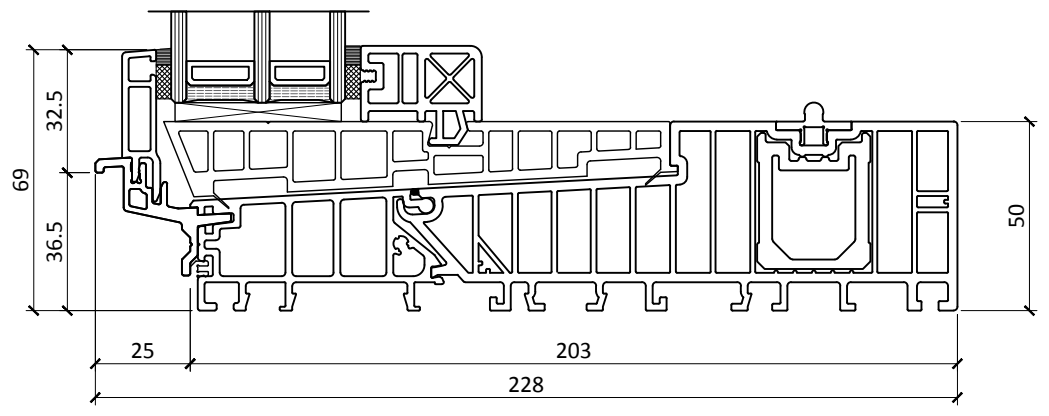
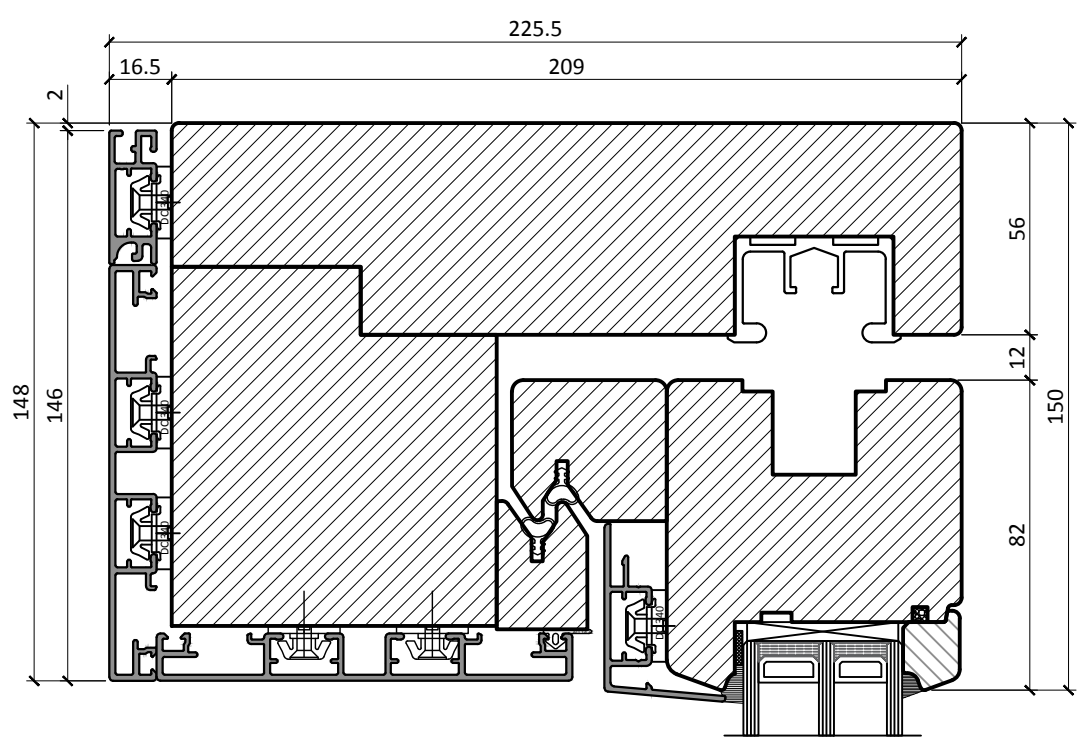
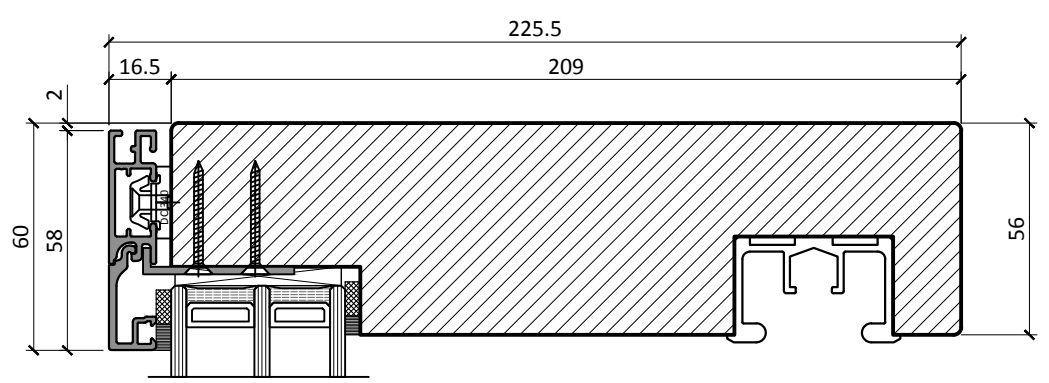

TRC ARE AN ISO 9001 REGISTERED COMPANY



TRC CONTRACTS Ltd
 Knoll House, Union Wharf,
 Market Harborough,
 Leicestershire LE16 7UW
 Tel: +44 (0)1858 469 225
 Fax: +44 (0)1858 469 249
 www.trcwindows.co.uk



ALUMINIUM CLAD LIFT & SLIDE DOOR

TITLE

HORIZONTAL SECTION

DRAWING No.

LS-A-78/03

DATE

2020/11/17

SCALE

1:1.5 @ A3

CONSTRUCTION DETAILS

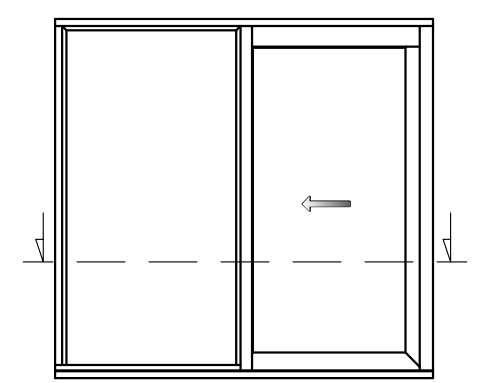
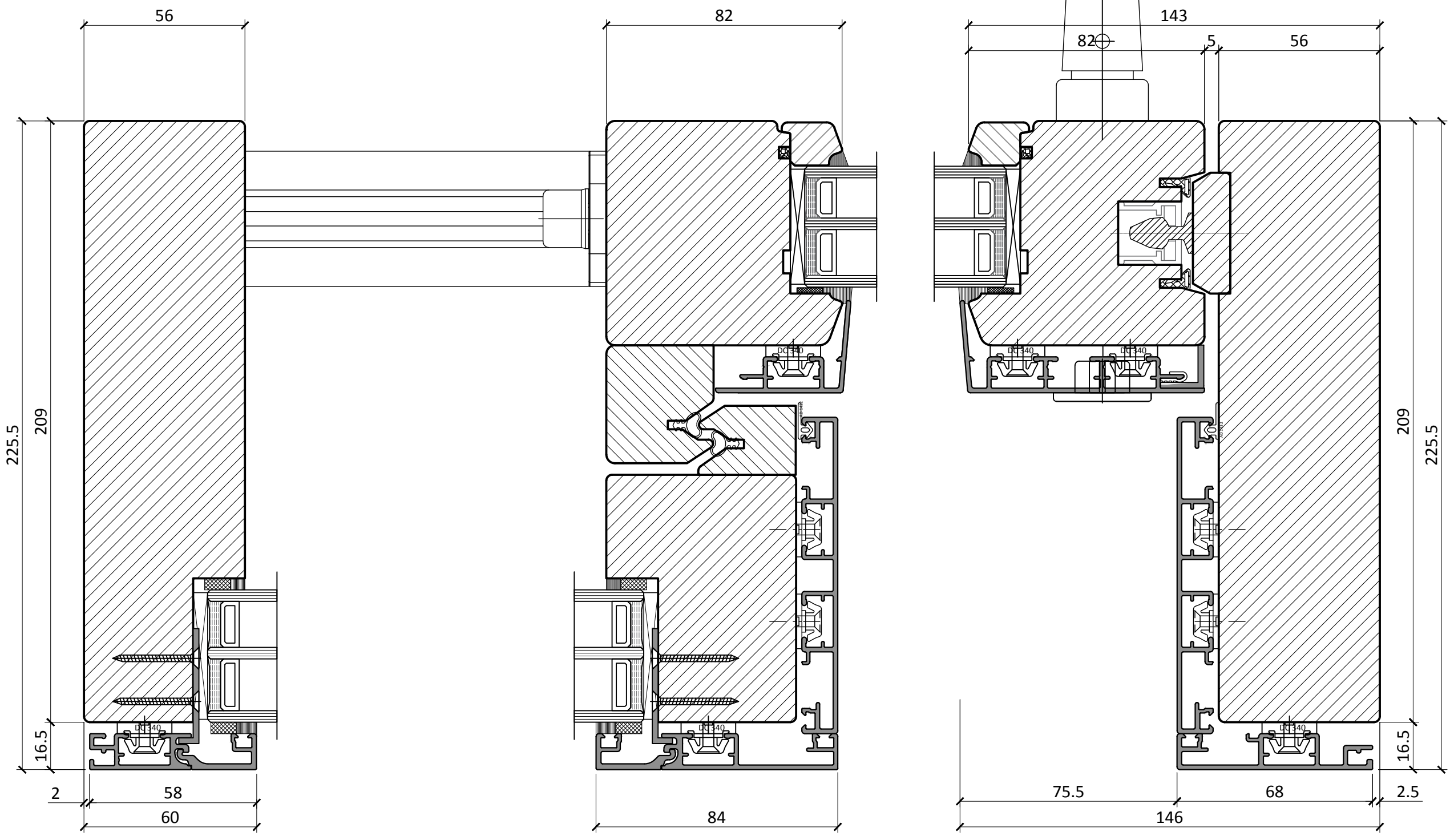

TRC ARE AN ISO 9001 REGISTERED COMPANY



TRC CONTRACTS Ltd
 Knoll House, Union Wharf,
 Market Harborough,
 Leicestershire LE16 7UW
 Tel: +44 (0)1858 469 225
 Fax: +44 (0)1858 469 249
 www.trcwindows.co.uk



ALUMINIUM CLAD LIFT & SLIDE DOOR

TITLE

HORIZONTAL SECTION

DRAWING No.

LS-A-78/04

DATE

2020/11/17

SCALE

CONSTRUCTION DETAILS

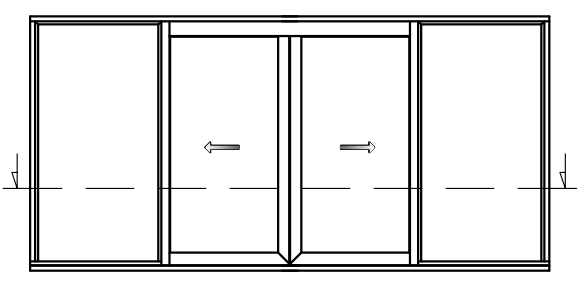
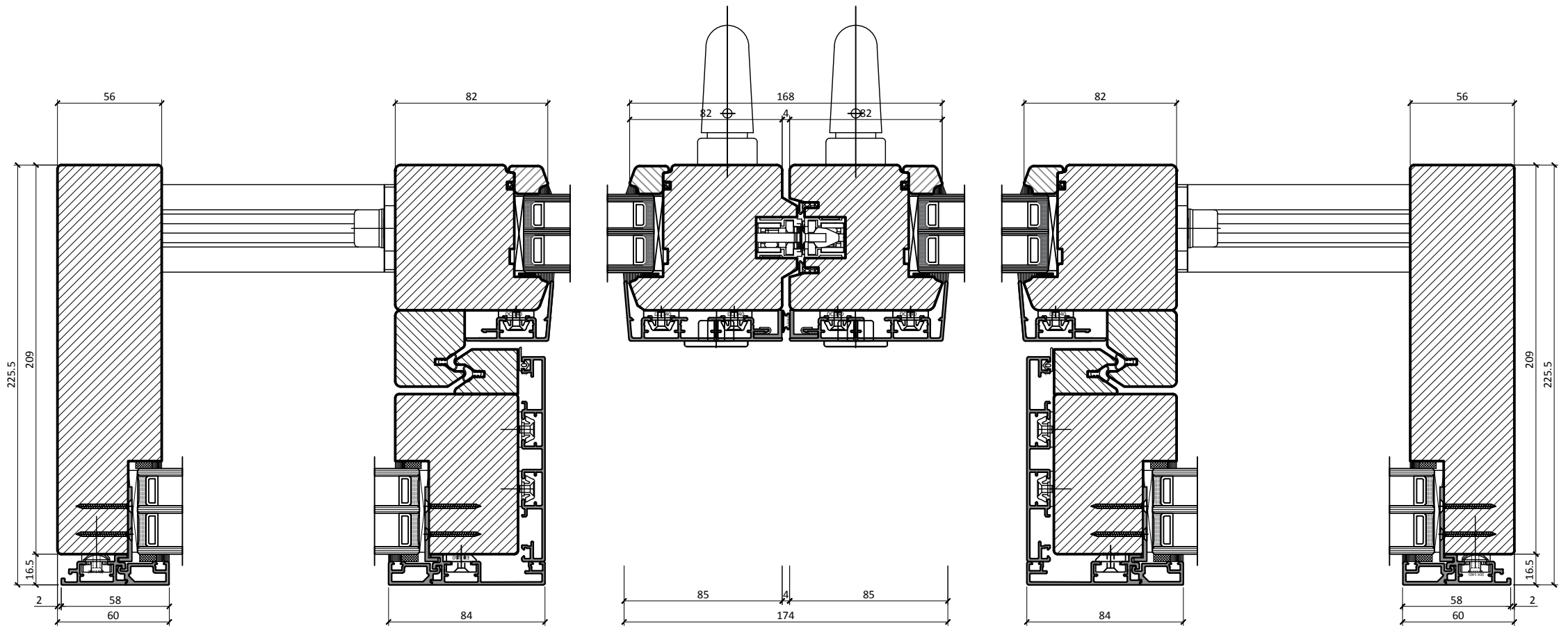
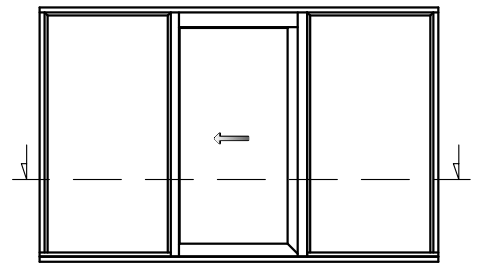
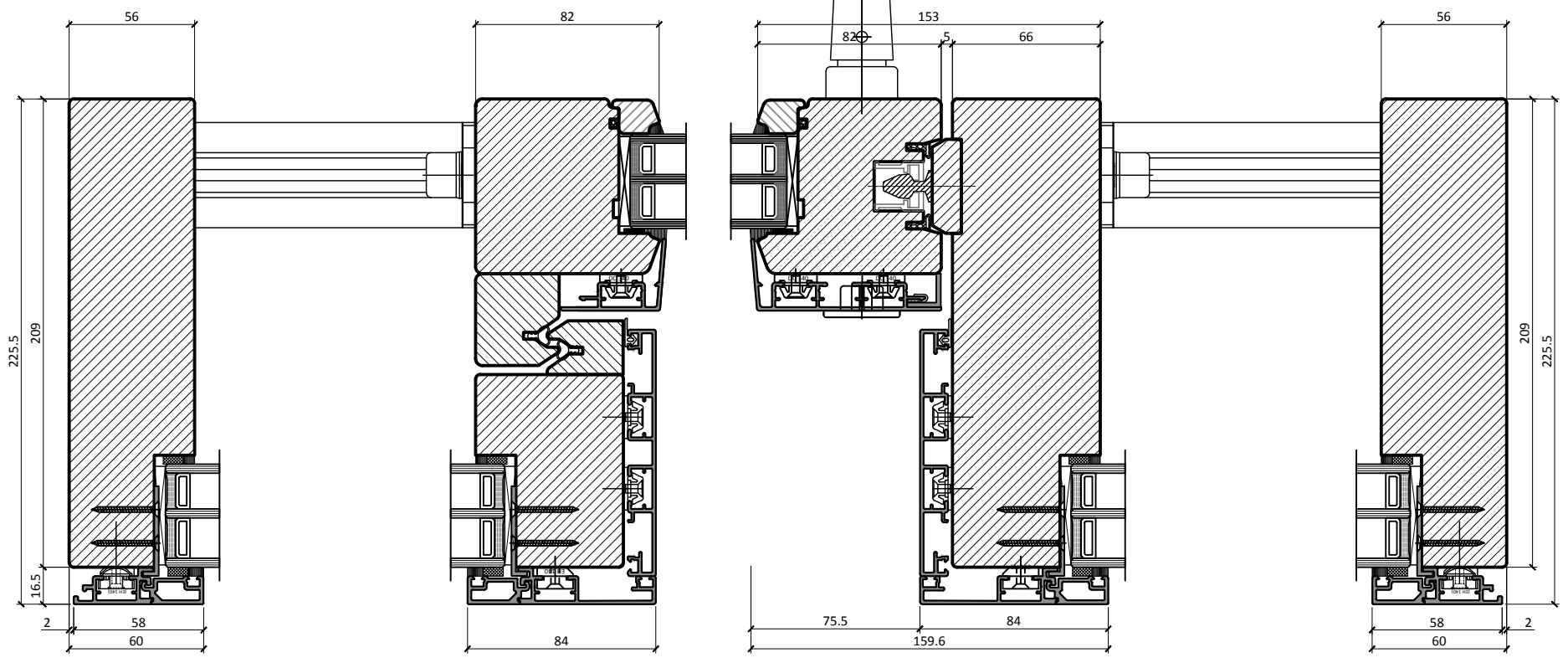

TRC CONTRACTS Ltd
 Knoll House, Union Wharf,
 Market Harborough,
 Leicestershire LE16 7UW
 Tel: +44 (0)1858 469 225
 Fax: +44 (0)1858 469 249
 www.trcwindows.co.uk

TRC ARE AN ISO 9001 REGISTERED COMPANY

